

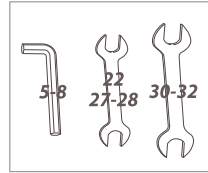

OTTONE

www.ottone.pl



Art.0688

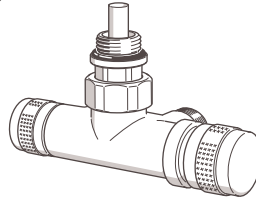

Art.0721

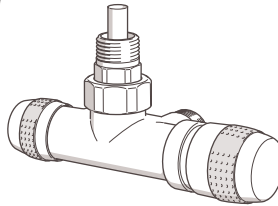

Art.0690

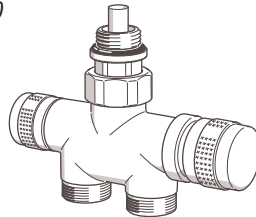

Art.0724

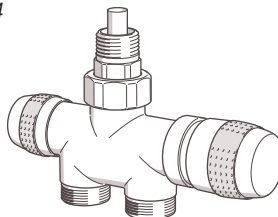

Zawór termostatyczny do grzejnika łazienkowego

instalacje
jednorurowe/dwururów

Thermostatic valve for column radiators

vertical connections
monotube/bitube





Art.0281
Art.0481

ø15

Art.0283
Art.0483

ø11.5/12-16

Art.0025/1

L = 700 mm
L = 1000 mm

Art.0471/1

Wkładka termostatyczna
dla kierunku przepływu B
Only with the flow in B

Art.0721

G - 1/2"
F - 24 x 19
L - 142
H - 54
A - 65
B - 38
C - 35

JEDNORUROWE/MONOTUBE

DWURUROWE/BITUBE



2 - 130° C (36-266° F)
Max 10 bar (145 psi)

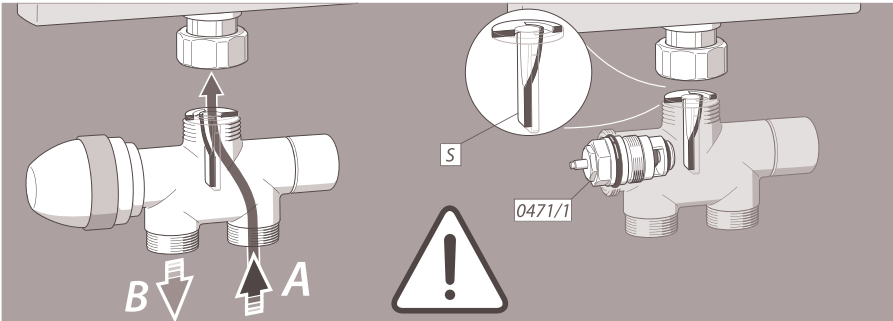
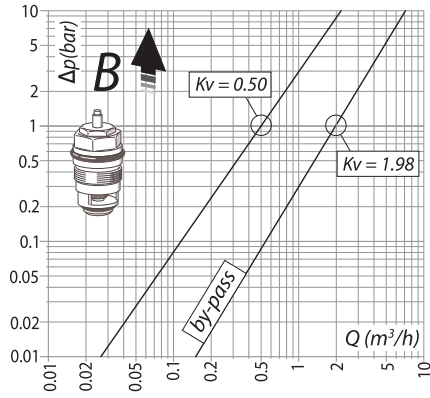
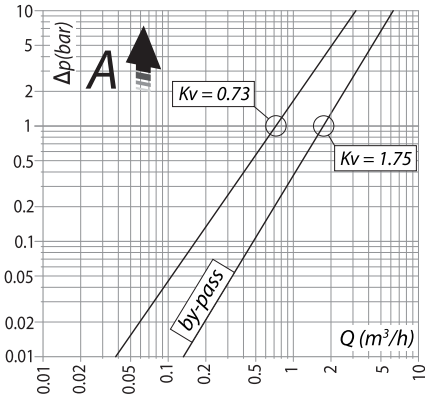

PL Aby zmienić kierunek przepływu należy wymienić wkładkę termostaticzną na art.0471/1 (dotyczy instalacji w których ciśnienie pracy wynosi powyżej 4 bar) obrócić separator (S) o 180°.

EN With the flow in B change the insert thermostatic by art.0471/1 and rotate separator (S) 180°.

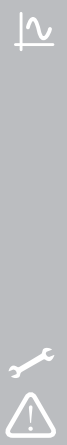
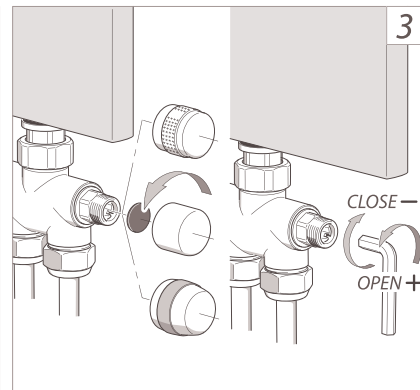
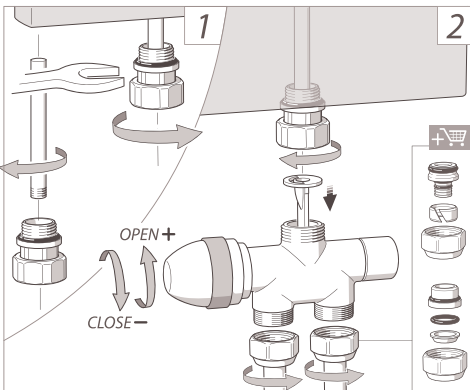

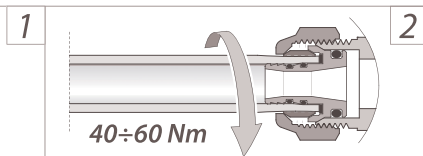
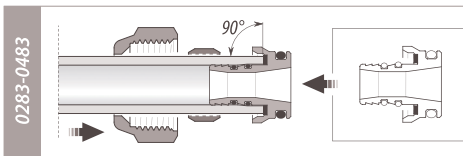
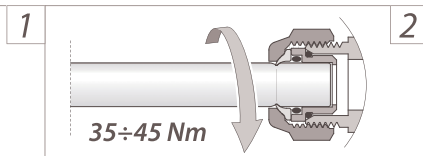
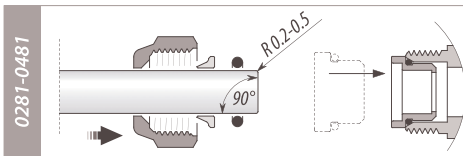
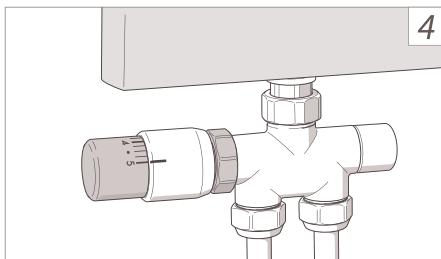
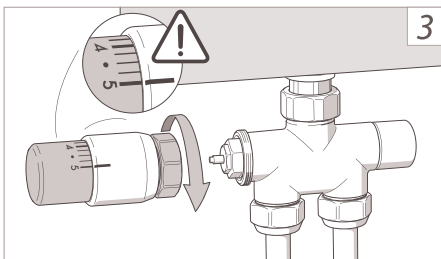
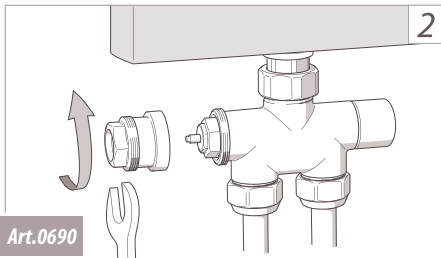
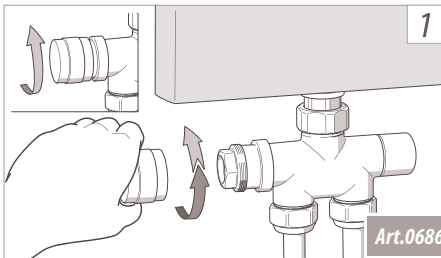
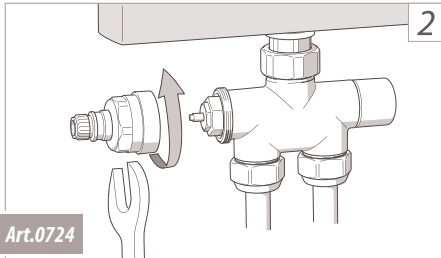
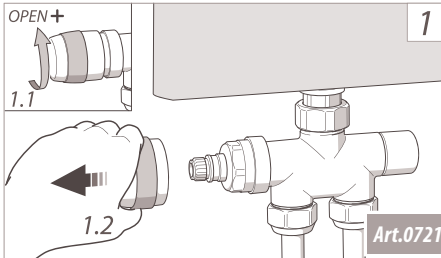

www.OTTONE.pl

OTTONE

Dystrybutor i gwarant:
OTTONE Brzegowa Szczygieł Sidelko Sp. J.
 Głogoczków 996, 32-444 Głogoczków
 tel.: 600 892 333 • biuro@ottone.pl